

FEM 1001/3

A3

USA

Lifting capacity **35 300/70 600 lbs**
 Max. Tragfähigkeit **16.0 / 32.0 t**

PEINER SK 565

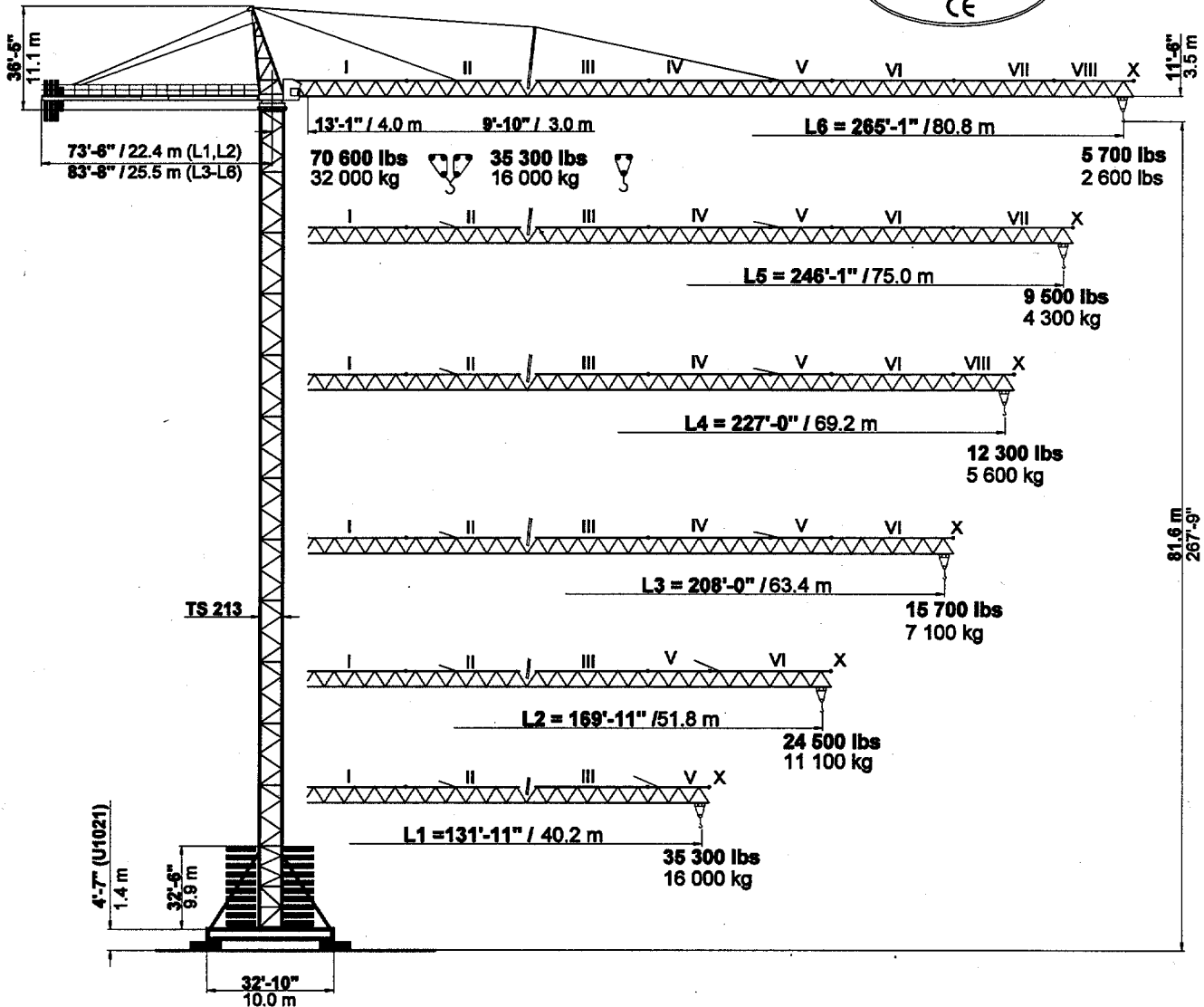
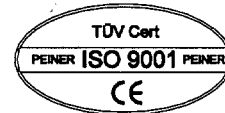

SK 565

Combinations of tower section, hook heights, forces acting per corner, base ballast Turmkombinationen, Hakenhöhen, Eckkräfte, Zentralballast

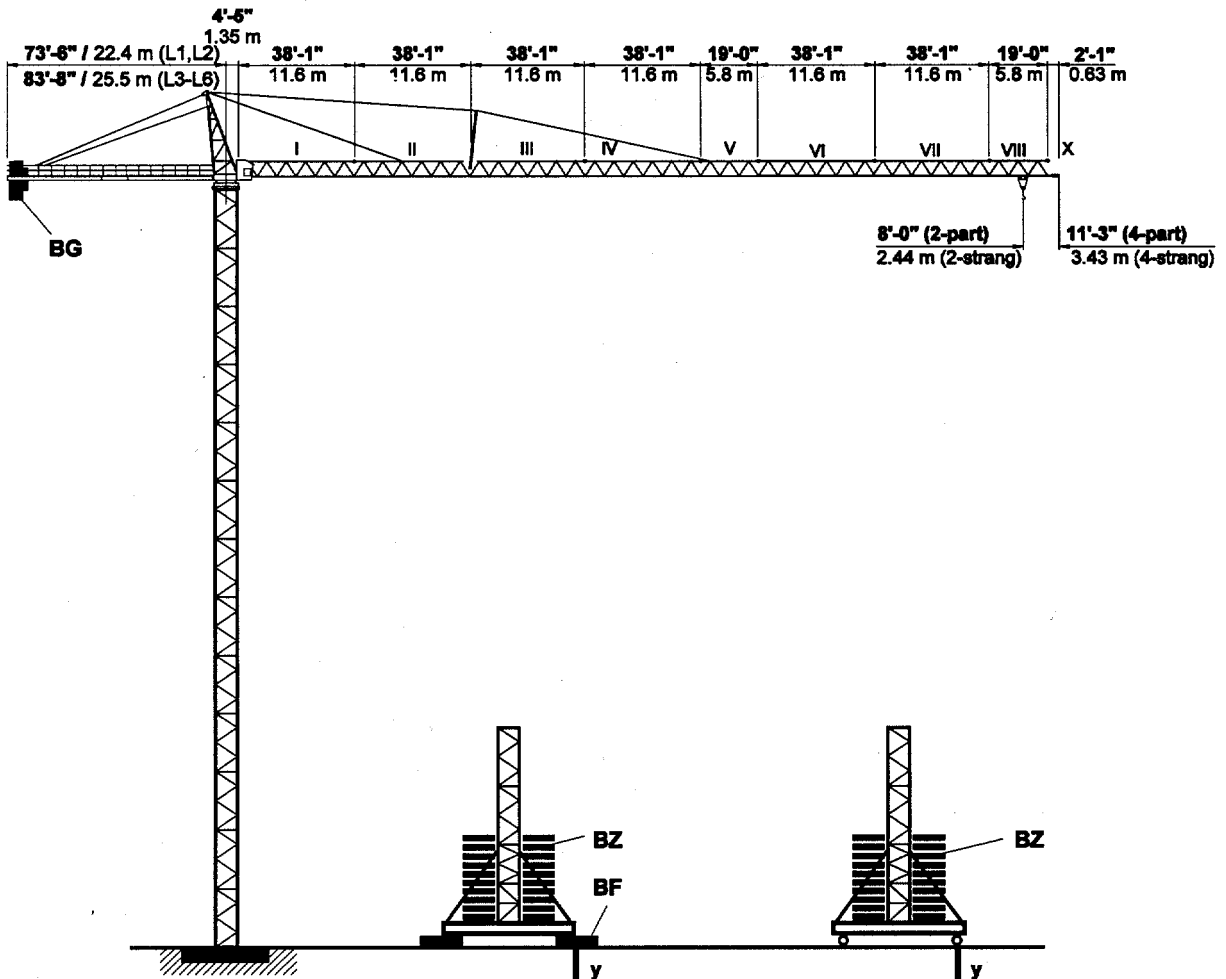

Version:

Version F - U 1021

Version E - UF 1021

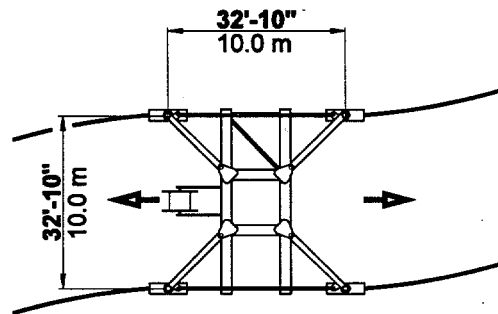
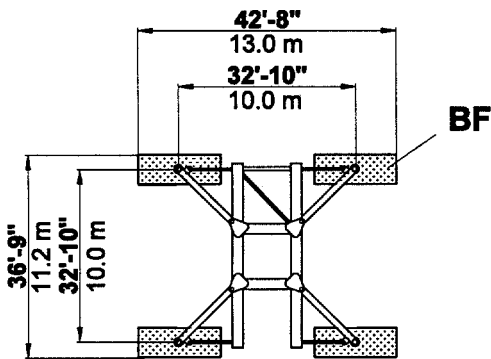

Ground support
Bodenaufgaben

Version:

A

F

F / SP

E

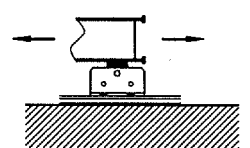
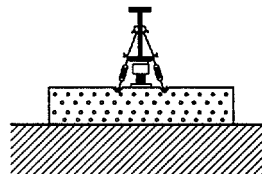
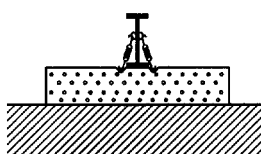
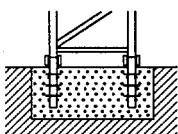

SK 565 Tower / Turm TS 213

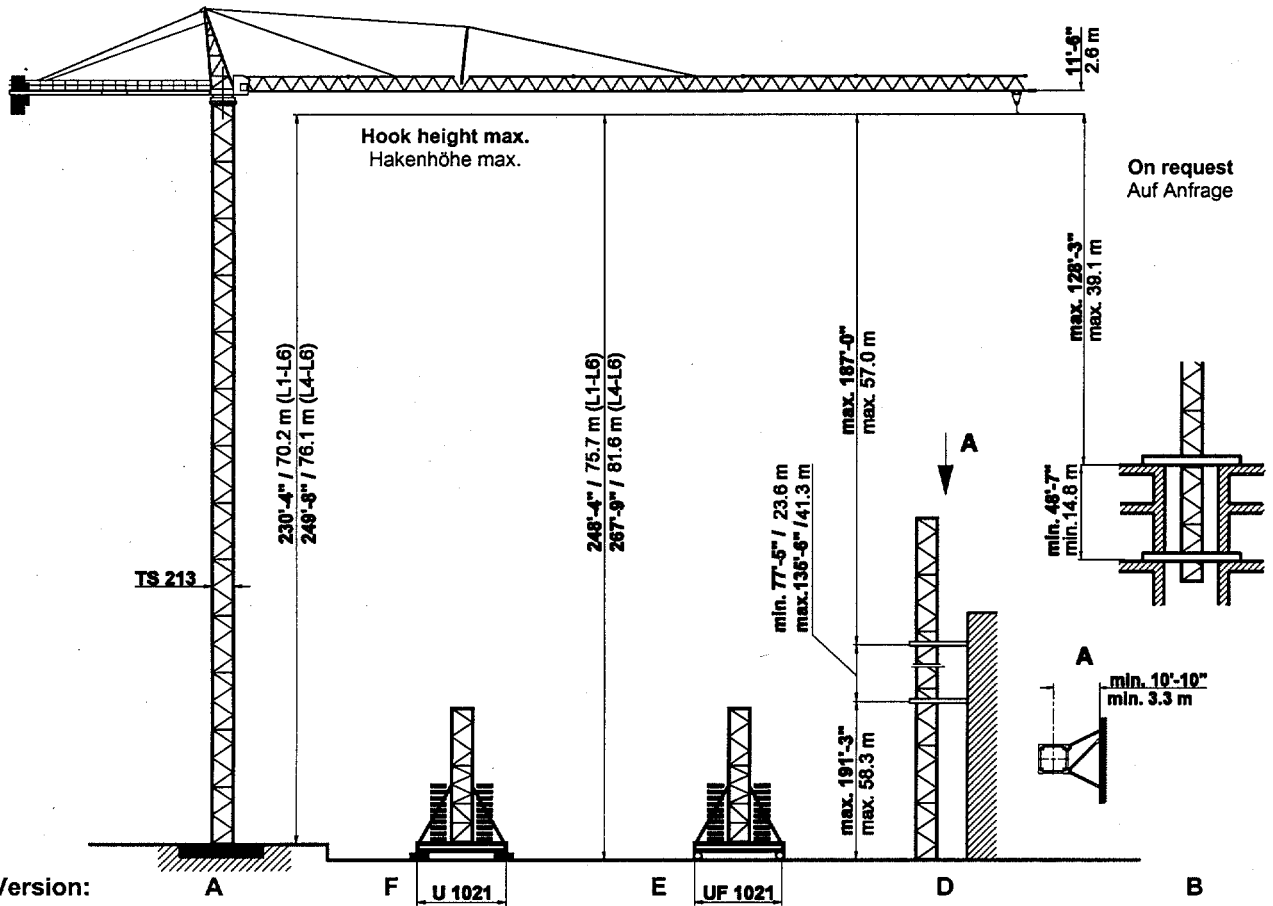









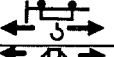

TS 213 Turm TS 213.1	Version A		Version F				Version E								
	HH ft m	Tower Turm TSV 213 TS 213.1	HH ft m	BZ + BF L1-L3 L4-L6 lbs t		y (L1-L3) i.B. a.B. kips kN		y (L4-L6) i.B. a.B. kips kN		BZ L1-L3 L4-L6 lbs t		y (L1-L3) i.B. a.B. kips kN		y (L4-L6) i.B. a.B. kips kN	
13 x TS 213.1	249'-5" 76.1	1 x TSV 213 12 x TS 213.1	267'-9" 81.6							-	203 700 92.4	-	-	280 1244	302 1345
12 x TS 213.1	230'-4" 70.2	1 x TSV 213 11 x TS 213.1	248'-4" 75.7							203 700 92.4	203 700 92.4	270 1203	255 1136	272 1209	307 1364
11 x TS 213.1	210'-11" 64.3	1 x TSV 213 10 x TS 213.1	229'-0" 69.8							203 700 92.4	145 500 66.0	263 1168	252 1123	254 1130	264 1176
10 x TS 213.1	191'-7" 58.4	1 x TSV 213 9 x TS 213.1	209'-8" 63.9							145 500 66.0	116 400 52.8	246 1092	223 991	236 1052	234 1042
9 x TS 213.1	172'-3" 52.5	1 x TSV 213 8 x TS 213.1	190'-3" 58.0							116 400 52.8	87 300 39.6	229 1018	194 864	219 976	205 914
8 x TS 213.1	152'-11" 46.6	1 x TSV 213 7 x TS 213.1	170'-11" 52.1							87 300 39.6	87 300 39.6	215 956	172 767	210 933	185 824
7 x TS 213.1	133'-6" 40.7	1 x TSV 213 6 x TS 213.1	151'-7" 46.2							87 300 39.6	87 300 39.6	207 919	162 722	201 892	166 740
6 x TS 213.1	114'-2" 34.8	1 x TSV 213 5 x TS 213.1	132'-3" 40.3							87 300 39.6	87 300 39.6	200 888	160 711	192 852	150 669
5 x TS 213.1	94'-10" 28.9	1 x TSV 213 4 x TS 213.1	112'-10" 34.4							87 300 39.6	87 300 39.6	193 860	157 699	183 813	143 637
4 x TS 213.1	75'-6" 23.0	1 x TSV 213 3 x TS 213.1	93'-6" 28.5							87 300 39.6	87 300 39.6	187 832	155 688	174 775	143 636
3 x TS 213.1	56'-1" 17.1	1 x TSV 213 2 x TS 213.1	74'-2" 22.6							87 300 39.6	87 300 39.6	181 806	152 677	168 747	138 615
2 x TS 213.1	36'-9" 11.2	1 x TSV 213 1 x TS 213.1	54'-9" 16.7							87 300 39.6	87 300 39.6	169 751	144 640	156 963	130 578
1 x TS 213.1	17'-5" 5.3	1 x TSV 213	35'-5" 10.8							87 300 39.6	87 300 39.6	164 729	141 629	151 670	127 567
Foundation Fundament 27'-11" x 27'-11" x 5'-7" 8.5 x 8.5 x 1.7 m						Stationary base Unterwagen U 1021				Railgoing base Unterwagen, kurvenfahrbar UF 1021					
Fundamentfüße Fixing angles 4 x FF 213				BF 4 x 13 220 lbs 4 x 6.0 t		BZ Block 14 550 lbs Block 6.6 t		Bogie / Fahrschemel Curve / Kurve 2 x F 400							

* Lower climbing section after erection. / Klettereinrichtung nach Montage ablassen.
TS 213.1 = 19'4 1/4" / 5.9 m **TSV 213 = 32'-5 3/4" / 9.9 m**

SK 565 Radius and capacity / Ausladung und Tragfähigkeit

Jib Ausleger	Max. capacity max. Tragfähigkeit	Radius (ft) and capacity (lbs) Ausladung (m) und Tragfähigkeit (t)																		
		70'-3"	78'-9"	85'-4"	91'-10"	105'-0"	111'-7"	118'-1"	131'-11"	144'-4"	157'-6"	169'-11"	190'-3"	208'-0"	216'-6"	227'-0"	236'-3"	246'-1"	255'-11"	265'-11"
ft m	35 300 lbs 16.0 t	21.4	24.0	26.0	28.0	32.0	34.0	36.0	40.2	44.0	48.0	51.8	58.0	63.4	66.0	69.2	72.0	75.0	78.0	80.8
L6 265'-1" 80.8	9'-10" - 65'-0" 3.0 - 19.8 m	3200	27800	25400	23200	19900	18300	17200	15000	13500	11900	10800	9300	8200	7700	7300	6800	6400	6200	5700
L5 246'-1" 75.0	9'-10" - 84'-0" 3.0 - 25.6 m	35300	35300	34600	31800	27100	25400	23600	20900	18500	16800	15200	13200	11900	11200	10600	9900	9500		
L4 227'-0" 69.2	9'-10" - 94'-6" 3.0 - 28.8 m	35300	35300	35300	35300	31100	29100	27100	23800	21400	19400	17700	15400	13700	13200	12300				
L3 208'-0" 63.4	9'-10" - 104'-4" 3.0 - 31.8 m	35300	35300	35300	35300	34800	32600	30400	26900	24300	21900	20100	17500	15700						
L2 169'-11" 51.8	9'-10" - 124'-0" 3.0 - 37.8 m	35300	35300	35300	35300	35300	35300	35300	32600	29500	26700	24500								
L1 131'-11" 40.2	9'-10" - 131'-11" 3.0 - 40.2 m	35300	35300	35300	35300	35300	35300	35300	35300											
ft m	70 600 lbs 32.0 t	 max. 70 600 lbs max. 32.0 t Radius / Ausladung -3'-3" (- 1.0 m)																		
L6 261'-10" 79.8	13'-1" - 34'-5" 4.0 - 10.5 m	28900	24700	22300	20100	16800	15200	14100	11900	10400	8800	7700	6200	5100	4600	4200	3700	3300	3100	2600
L5 242'-9" 74.0	13'-1" - 44'-0" 4.0 - 13.4 m	40100	32200	31300	28700	24000	22300	20500	17600	15400	13700	12100	32200	8600	8200	7500	6800	6400		
L4 223'-9" 68.2	13'-1" - 48'-11" 4.0 - 14.9 m	45900	40100	36400	32200	28000	26000	24000	20700	18300	16300	14600	12300	10600	10100	9300				
L3 204'-9" 62.4	13'-1" - 53'-10" 4.0 - 16.4 m	54500	45000	40800	37300	31700	31700	27300	23800	21200	18700	17000	14300	12600						
L2 166'-8" 50.8	13'-1" - 53'-0" 4.0 - 19.2 m	62800	54900	50000	58900	39000	36200	32200	29500	26500	23600	21200								
L1 128'-7" 39.2	13'-1" - 70'-3" 4.0 - 21.4 m	70600	61700	56200	51400	43900	40800	38100	34000											

Speeds / Geschwindigkeiten

FU 11-400/4		v = 0 → ~260 fpm (80 m / min.)	14.96 HP 11.0 kW
SR 10-190/4		v = 0 → 115 fpm (36 m / min.)	4 x 12.24 HP 4 x 9.0 kW
SR WB 150/4		v = 0 → 1.0 rpm (min ⁻¹)	L1, L2 L3, L4, L5, L6 2 x 12.24 HP 2 x 9.0 kW 3 x 12.24 HP 3 x 9.0 kW
 HK max. = 722' (220 m) 5 - layers / 5 -Lagen			480 V / 60 Hz / 3 ph
Type SR WB 102- 160/4F 166.5 HP 122.4 kW		 → 492 fpm 150 m/min 7 700 lbs 3 500 kg	 → 246 fpm 75 m/min 15 400 lbs 7 000 kg Total motor output Motorenleistung ges. ~140 HP without / ohne SR 10-190/4 ~105 kW Connected power 240 kVA Anschlußleistung
		 → 312 fpm 96 m/min 13 200 lbs 6 000 kg	
		 → 192 fpm 60 m/min 22 000 lbs 10 000 kg	
		 → 126 fpm 38 m/min 35 300 lbs 16 000 kg	

Counterweight / Gegengewicht

Jib / Ausleger		L 1	L 2	L 3*	L 4*	L 5*	L 6*
Counterweight Gegengewicht	BG	23 150 kg 50 800 lbs	24 800 kg 54 400 lbs	24 600 kg 54 000 lbs	24 800 kg 54 400 lbs	26 250 kg 57 600 lbs	26 250 kg 57 600 lbs
	[lbs]	7 x 6 800 1 x 3 200	8 x 6 800	7 x 6 800 2 x 3 200	8 x 6 800	8 x 6 800 1 x 3 200	8 x 6 800 1 x 3 200
	[t]	7 x 3.10 1 x 1.45	8 x 3.10	7 x 3.10 2 x 1.45	8 x 3.10	8 x 3.10 1 x 1.45	8 x 3.10 1 x 1.45

* with counter jib section 2 / mit Gegenausleger 2

SK 565 Transportmaße und Transportgewichte

Dimensions and weights of transport

Mounting weights see operating manual!
Montagegewichte siehe Betriebsanleitung!

	Designation Benennung		Dimensions (ft / m) Abmessungen (ft / m)			Weight Gewicht lbs / t	Volume Volume ft ³ / m ³	
			l	b	h			
1	Jib / Ausleger Section / Schuss I		38.72	6.07	6.24	10 360	1 467	
	Section / Schuss II		11.80	1.85	1.90	4.70	41.5	
	Section / Schuss III		38.72	6.07	6.24	8 200	1 467	
	Section / Schuss IV		11.80	1.85	1.90	3.72	41.5	
	Section / Schuss V		38.72	6.07	6.07	5 000	1 427	
	Section / Schuss VI		11.80	1.85	1.85	2.27	40.4	
	Section / Schuss VII		38.72	6.07	6.07	4 650	1 427	
	Section / Schuss VIII		11.80	1.85	1.85	2.11	40.4	
	Section / Schuss IX		19.69	6.07	6.07	2 530	726	
	Jib tip / Seilstation X		6.00	1.85	1.85	1.15	20.5	
			38.72	6.07	5.91	3 860	1 389	
			11.80	1.85	1.80	1.75	39.3	
			38.72	6.07	5.91	2 530	1 389	
			11.80	1.85	1.80	1.15	39.3	
			19.69	6.07	5.91	1 210	706	
			6.00	1.85	1.80	0.55	19.9	
			4.92	6.76	1.67	490	56	
			1.50	2.06	0.51	0.22	1.6	
2	Tower top compl. Turmspitze kpl.		29.86 9.10	7.22 2.20	8.86 2.70	8 270 3.75	1 910 54.0	
3	Turntable with slewing ring support and motors Drehbühne mit Drehkranzaufgabe u. Motoren		10.50 3.20	8.20 2.50	8.86 2.70	26 890 12.20	763 21.6	
4	Cabin / Kabine		5.41 1.65	3.61 1.10	7.15 2.18	1 040 0.47	139 3.9	
	Support, railing, electrical panel Podest, Geländer, Schaltschrank		11.65 3.55	6.56 2.00	6.40 1.95	3 220 1.46	489 13.8	
5	Counter jib with hoist winch Gegenausleger mit Hubwinde		G1	38.55 11.75	8.20 2.50	5.84 1.78	19 400 8.80	1 846 52.3
			G2	10.34 3.15	6.63 2.02	5.25 1.60	2 160 0.98	360 10.2
			G3	30.74 9.37	6.63 2.02	5.25 1.60	6 280 2.85	1 070 30.3
	Hoist winch Hubwinde	102 WB	11.48 3.50	7.41 2.26	3.94 1.20	12 720 5.77	335 9.5	
6	Counterweight Gegengewicht		BG	5.08 1.55	0.19 0.63	14.76 4.50	6 800 3.10	47 1.3
				5.08 1.55	0.14 0.46	8.99 2.74	3 200 1.45	21 0.6
7	Tower section Turmschuss		TS 213.1	19.52 5.95	7.84 2.39	7.81 2.81	9 790 4.44	1 195 33.8
			TSV 213	39.37 12.00	10.34 3.15	10.34 3.15	31 090 14.10	4 209 119.0
8	Movable undercarriage, folded Unterwagen, kurvenfahrbar, geklappt		UF 1021	43.96 13.40	9.51 2.90	3.77 1.55	1 576 37 700	85.2 17.10
				8.20 2.50	2.69 0.89	2.82 0.89	64 1.8	
9	Central ballast block Zentralballaststein	BZ	14.77 4.50	6.73 2.05	1.31 0.40	14 550 6.60	130 3.7	
10	Foundation pad Fundamentblock	BF	9.84 3.00	3.94 1.20	2.46 0.75	13 230 6.00	95 2.7	
11	Accessories Diverse Montageteile							